

Lecologico®

AS870 PARQUET

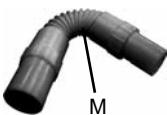

 **Politi®**
INNOVATIVE BY NATURE.

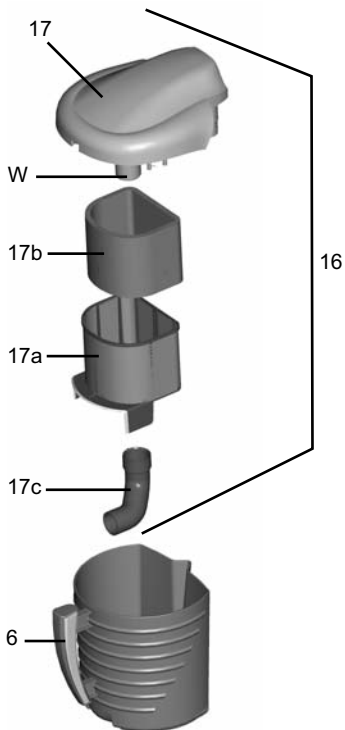
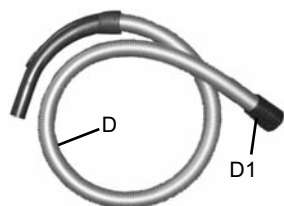
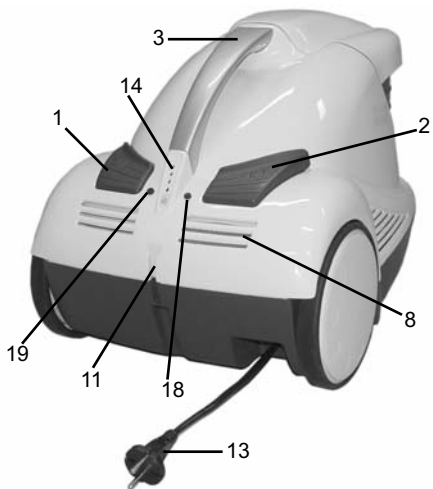

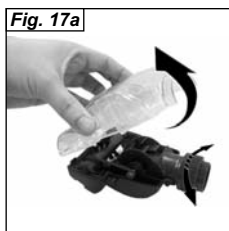
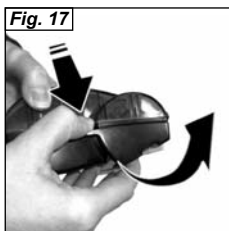
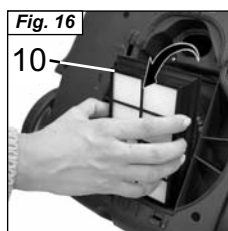
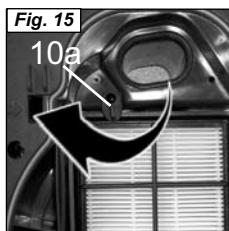
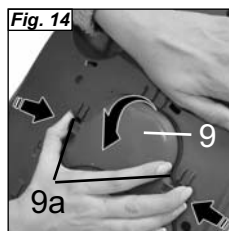
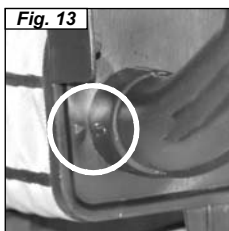
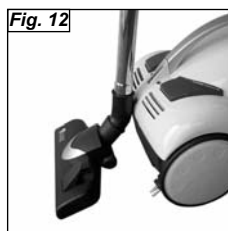
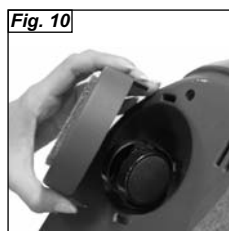
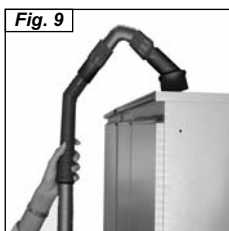
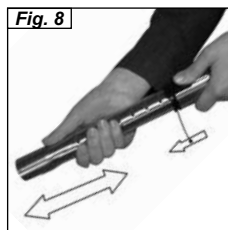
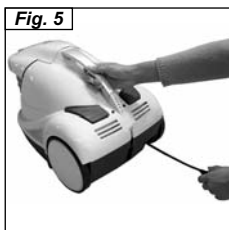
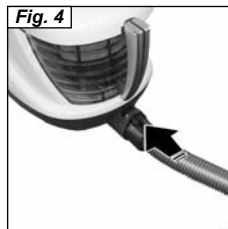
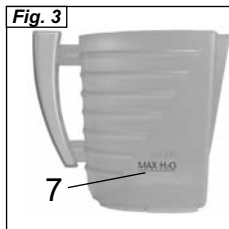
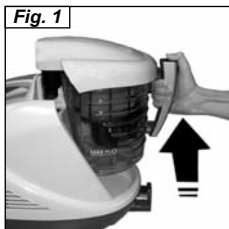



Read these instructions carefully before using the appliance.

Dear Customer,

We would like to thank you for choosing this Polti appliance.

By choosing Lecologico, you have made a healthy choice for your home. Lecologico by Polti is a friend of the environment and an enemy to dust, pollens, dust mites and their allergens. With its EcoActive-Filter, Lecologico traps dust in water; then the dirty water is simply poured away- so no risk of dispersing the dust into the air around you. When you've finished, you can put your Lecologico away perfectly clean.

With Polti's Lecologico you can sigh with relief indeed. Its 4-stage filtering system with HEPA filter guarantees that the air coming out of the vacuum cleaner is perfectly clean. The EcoActive-Filter also does away with the need for dusty bags and all the unpleasant handling of them. With Lecologico you can vacuum up dry dirt, including large objects. Or even vacuum up a limited amount of liquids, solving the problem of minor home troubles.

A complete set of accessories is provided to help you to do all cleaning tasks quickly and without effort. We suggest to you to read this instruction booklet carefully before using your Lecologico.

What is EcoActive-Filter?

EcoActive-Filter is the revolutionary "green" heart of Lecologico, because its effectiveness is based on the natural purifying force of water. Just the water flow contained in the special filter and its bubbling imprison dirt, preventing all contact with dust, and avoiding dispersal of dust back into the air.

What is the HEPA filter?

Lecologico has a special extra powerful washable HEPA filter, previously used only in professional applications requiring the utmost hygiene. This filter stops even the finest dust, pollens, dust mites and other microorganisms and is easily rinsed clean when dirty.

KEY

- 1) Main switch
- 2) Cable winder button
- 3) Carry handle
- 4) Container handle
- 5) Rear wheels
- 6) "EcoActive-Filter" water container
- 7) MAX level (fig.3)
- 8) Air outlet grid
- 9) Filter cover (fig.13)
- 9a) Filter cover opening levers (fig.13)
- 10) Hepa filter (fig.15)
- 10a) Hepa filter retainer (fig.14)
- 11) Accessories holder housing
- 12) Casters
- 13) Power cable plug
- 14) Indicator lights
- 15) Connection
- 16) "Eco Active Filter" water filter assembly
- 17) Filter cage cover
- 17a) Filter cage body with fine mesh
- 17b) Sponge filter
- 17c) Filter nozzle
- 18) On/off and increased suction power button
- 19) Decreased suction power button

KEY TO ACCESSORIES

- A) Telescopic tube
- A1) Telescopic tube release button
- B) Joker brush
- C) Universal brush
- C1) Brush selector
- D) Hose
- D1) Suction opening
- E) Multipurpose nozzle
- F) Lance for cleaning corners / skirting boards
- G) Soft brush
- L) Radiator brush
- M) Jointed tube
- N) Mini turbo brush
- O) Parquet brush
- P) Wheel covers for hardwood floors
- P1) Wheel covers anchoring joints
- W) Float
- X) HP007
- Z) Water container cleaning brush

CE This unit conforms with EC-directives 89/336 as amended by 93/68 (EMC) and 73/23 as amended by 93/68 (low voltage).

Polti S.p.A. reserves the right to change equipment or accessory specification without prior notice.

PRECAUTIONS

KEEP THESE INSTRUCTIONS

- Read these instructions for use carefully before using the appliance.
- Any use which does not comply with these instructions will invalidate the warranty.
- The wiring system to which the appliance is connected must always comply with the laws in force.
- Before connecting the appliance, make sure that the mains voltage is the same as the voltage indicated on the data label of the appliance and that the power outlet is connected to earth
- Always turn off the appliance at the on/off switch before unplugging it.
- If the appliance is left unused, always disconnect it from the mains. Never leave the appliance unattended with the cable plugged into the mains.
- Always make sure the appliance is unplugged before performing maintenance work of any kind
- Do not pull the power cable out of the socket, but grasp the plug itself to avoid damage to the socket.
- Do not allow the power cable to be twisted, crushed, stretched, or come into contact with sharp or hot surfaces.
- Do not use the appliance if the power cable or other important parts are damaged.
- Do not use electric extension leads that are not authorized by the manufacturer, as they may cause damage or fire.
- If it is necessary to replace the power supply cable, please refer to the nearest Polti authorised service centre, since the use of a special tool is necessary.
- Never touch the appliance with wet hands or feet with the cable plugged into the mains.
- Do not use the appliance when barefoot.
- Do not use the appliance near a bathtub, shower or container full of water
- Never immerse the appliance, the cable or the plugs in water or another liquid.
- Use of the appliance in places where there is a danger of explosions is prohibited.
- Do not use the product with toxic substances.
- Do not lay the hot appliance on surfaces sensitive to heat.
- Do not leave the appliance exposed to wind or rain.
- Do not place the appliance near a live element, an electric stove or any other source of heat.
- Do not expose the appliance to extreme temperatures
- Never let children or people who are not familiar with how the appliance works use it.
- Do not press the buttons hard or with a pointed object such as a pen.
- Always rest the appliance on a stable surface.
- In case of accidental fall of the appliance it is necessary to have it checked by an authorized Service Centre as the internal safety features may have been affected.
- In case of breakdown or malfunction switch off the appliance and never attempt to disassemble it, but refer to an authorized Service Centre.
- In order to avoid prejudicing the safety of the appliance, use only original spare parts and accessories approved by the manufacturer.
- Do not wind the power cable around the appliance, especially when the appliance is still hot.
- Do not use the appliance to suck up acids or solvents, as these might cause serious damage to the appliance and above all do not suck up explosive dust or liquids, as these could cause explosions on coming into contact with the inside components of the appliance.
- Do not suck up toxic substances.

- Do not suck up burning or incandescent objects such as embers, ash or other material in which combustion is taking place.
- Do not suck up detergents or other substances which could generate foam inside the water container, as this could cause malfunctioning.
- Water container can be filled with tap water.
- Do not suck up materials such as cement, chalk etc. which solidify once they come in contact with water thus damaging the appliance.
- During refilling with water, switch off and disconnect the appliance from the mains.
- It is necessary to keep the unit in horizontal position during operation.
- Leave the appliance to cool down before cleaning it.
- Before storing the appliance be sure that it has completely cooled down.
- **We recommend you use original Polti products only, as products of other brands may not be suitable for use in Polti products and could cause damage.**
- This appliance is not intended for use by persons (including children) with reduced physical, sensory or mental capabilities, or lack of experience and knowledge, unless they have been given supervision or instruction concerning use of the appliance by a person responsible for their safety.
- Children should be supervised to ensure that they do not play with the appliance.
- The appliance must not be used if it has fallen, been dropped or when it has visible signs of damage or leaks.
- If the supply cord is damaged, it must be replaced by the manufacturer, its service agent or similarly qualified persons in order to avoid a hazard.

CORRECT USE OF THE PRODUCT

This appliance is intended for home use for sucking up liquids and solids as described and in accordance with the instructions provided in this manual.

Please read these instructions carefully and keep them, as you may find them useful in fu-

ture.

Politi declines liability for any damage or accident derived from any use of Leco-logico which is not in conformity with the instructions contained in this booklet.

ATTENTION

Directive 2002/96/EC (Waste Electrical and Electronic Equipment - WEEE): information for users

This product complies with EU Directive 2002/96/EC.

The crossed-out wastebasket symbol on the appliance means that at the end of its useful lifespan, the product must be disposed of separately from ordinary household wastes.



The user is responsible for delivering the appliance to an appropriate collection facility at the end of its useful lifespan.

Appropriate separate collection to permit recycling, treatment and environmentally compatible disposal helps prevent negative impact on the environment and human health and promotes recycling of the materials making up the product. For more information on available collection facilities, contact your local waste collection service or the shop where you bought this appliance.

PREPARATION FOR USE

- Remove the water container (6) from the appliance, holding it by the handle (4) (fig.1).
- Remove the filter assembly (16) (fig.2).
Fill the water container (6) with ordinary tap water up to the MAX H₂O indicator (7) as shown in figure 3. The required quantity is 800cc of water.
- Place the filter assembly (16) in the water container (6), being careful to align them perfectly.
- Put the water container (6) back inside the appliance, performing the operations listed above in reverse order.

LECOLOGICO AS 870 PARQUET

- Insert the suction opening (**D1**) on the hose (**D**) into connection (**15**) (fig.4).

FUNCTIONING

- Unwind the cable (**13**) to remove it COMPLETELY from its housing, pulling the plug towards you (fig.5).
- Plug into a suitable power outlet.
- Press the main switch (**1**) (fig.6) and the first level of the indicator lights (**14**) will begin flashing. This means Lecologico is in the pause position. Hold down the button (**18**) for more than one second, then release it. Lecologico will begin operating at minimum speed, and the first indicator light (**14**) will stay on.
- There are four power levels. We recommend **minimum** power for curtains, **medium/low** power for sofas, armchairs and cushions, **medium/high** for carpets and **high** for floors and hard surfaces (ceramics, marble, etc.).
- Press button (**18**) to increase speed; each time you press button (**18**), the motor power increases by one step. At each speed increase a further level of the indicator lights come on.
- Press button (**19**) to decrease speed; at each speed decrease a further level of the indicator lights goes out.
- To restore the appliance to the pause position, hold down button (**18**) for more than one second, then release it.

DRY – LIQUID SUCTION

The appliance can be used in the same way to vacuum up dust or limited amount of liquids. If the water is very dirty, replace it as described in the section on “Emptying and cleaning the water container”. When the dirt collected in the water container (**6**) reaches the maximum permitted level, the safety float (**W**) will automatically stop the suction. The motor will turn over audibly faster. After 10 seconds the appliance will automatically pause and the four indicator lights (**14**) will start flashing. To resume cleaning, perform the operations described in the section on

“emptying and cleaning the water container”, then top up the water level in the container.

BIOECOLOGICO

Bioecologico is an anti-foaming and deodorising product based on natural substances which prevents foaming inside the water filter thus ensuring a correct working of the appliance. Diluted inside the dirt collection tank, Bioecologico also acts as an effective deodoriser while the appliance is running, and thanks to its composition which contains Tea Tree and other natural substances, it prevents bad smells inside the dirt collection tank and releases a fresh clean fragrance in the environment.

Use:

- shake the bottle before use and remove the lid;
- hold the bottle upright and squeeze 5 ml into the dispenser. Stop squeezing and pour the contents of the dispenser into the dirt container of the appliance;
- add water according to the instructions of the appliance.
- use the recommended quantity of Bioecologico at any refill of the dirt collection tank.
- recommended quantity: 5 ml

Note: a possible change in colour of the liquid does not alter the functional character and the efficiency of the product.

Do not swallow. Keep out of the reach of children.

CONTAINS: Eugenol, Citral, Cinnamal*

Contents: 100 ml

Bioecologico is available in pine or citrus scents.

Bioecologico is available to purchase from your local Polti retailer.

**May cause allergic reaction (in direct contact with the skin).*

EMPTYING AND CLEANING THE

WATER CONTAINER (6)

Turn off the appliance with the main switch (1) and unplug the power cable. This precaution also resets the safety device.

Remove the water container (6) from the appliance, holding it by the handle (4) (fig.1). Remove the filter assembly (16) (fig.2), empty the container tipping it toward the side with the spout (fig.7), and then rinse it out. Top up the water level if you want to continue working.

Reassemble the filter cage and put it back inside the appliance. The appliance is now ready to be put away.

Note: water in the container will not damage the appliance, but it is advisable to empty the container before putting away Lecologico. One of the greatest benefits offered by Lecologico is the fact that you can put it away clean, unlike vacuum cleaners with bags, which must be put away with the dirt in the bag.

USING THE ACCESSORIES

Accessories can be connected directly to the hose (D) or to the telescopic tube (A) or to the jointed tube (M).

Using the telescopic tube (A)

To increase or decrease length, press the release button (A1) positioned as shown in fig.8 and extend or reduce length as desired.

Jointed tube (M)

The handy jointed tube is particularly adaptable as it can be folded and adjusted to suit the task in hand. It is handy for cleaning spots that are hard to reach with traditional tools, such as high shelves, the tops of wardrobes, underneath furniture, etc. All other accessories can be fitted to the jointed tube (fig.9).

Using the Joker brush (B)

The Joker brush can be used to vacuum up solids or liquids on any kind of surface.

Using the universal brush (C)

Connect the brush to the telescopic tube. Press with your foot the selector on the brush

(C1) to change the suctioning surface without bending down. The position with bristles extended is recommended for all non-carpeted floors. The position without bristles is recommended for carpets.

Multipurpose nozzle (E)

The multipurpose nozzle is recommended for cleaning upholstery surfaces such as the joints of sofas, armchairs, mattresses, car upholstery, etc.

Lance for cleaning corners/skirting boards (F) – radiator brush (L)

The lance (F) is recommended for thorough vacuum cleaning of hard-to-reach spots such as skirting-boards and folds in sofas, armchairs, upholstered furniture and car upholstery. Apply the radiator brush (L) to the tip of the lance (F) to clean inside radiator elements and remove accumulated dust.

Soft brush (G)

The soft brush has soft bristles for dusting delicate surfaces such as picture frames, books, etc.

Mini turbo brush (N)

The mini turbo brush is particularly recommended for cleaning sofas and armchairs, car upholstery, fabric-covered walls, etc.

It easily removes dust, dandruff and textile residues. It is useful for preventing allergies, as the mechanical action of the roller with bristles vacuums up animal hair.

The mini turbo brush also has a hard rubber bristle attachment, useful on more difficult dirt. To remove the bristle attachment, press the two pivots found on the side of the brush and then remove it (fig.17)

(don't use the bristle attachment on delicate surfaces)

To clean the mini turbo brush, turn the nut and remove the upper part of the mini turbo brush, as shown in fig. 17a. Clean the inside of the brush and refit it by following these steps in reverse.

Parquet brush (O)

The parquet brush is designed to clean delicate surfaces; it has bristles and wheels in specially selected material to avoid damaging such surfaces.

Wheel covers for hardwood floors (P)

You should also use wheel covers (P) to prevent damage to your hardwood floor. To assemble wheel covers, simply fit together the two joints (P1) in the housings on the bottom of the appliance (fig.10). To release the tool, simply press the two joints (P1) inward and lift off the wheel cover.

AUTOMATIC CABLE WINDER

Before putting your vacuum cleaner away, rewind the power cable by pressing the button (2), as shown in fig.11, being careful to accompany it during winding.

USE OF THE ACCESSORIES HOLDER

The accessories holder allows to fix the tube with the brush mounted on it on the appliance body.

Reposition on the appliance body: make the groove on the back of the brush slide into the guide of the accessories holder on the appliance (Fig.12).

CLEANING THE WATER FILTER ASSEMBLY (16):

- Pull the nozzle (17c) until it comes off the filter cage. Separate the cage body (17a) from the cage cover (17).
- Remove the sponge filter (17b) from the cage. If the filter is damaged, replace it. Rinse all the components under running water. Let the sponge filter dry before putting it back into the appliance.
- Reassemble the filter assembly, repeating the operations in the reverse order.

Note: Make sure that the filter nozzle (17c) is correctly positioned, checking that the arrow on the nozzle is aligned with the notch on the bottom of the cage (17a) (fig.13).

- If the filter needs replacing, always use an original filter, available from Polti Technical Service Centres.
- A cleaning brush (Z) is supplied for easy

cleaning of the water container (6); it can also be used to clean the appliance's hose connections and the accessories inside.

NOTE: Do not use the brush for cleaning the outside of the appliance

CLEANING THE HEPA FILTER (10)

Proceed as follows to clean filters:

- press the two levers on the filter cover (9a) and pull off the filter cover (9) (fig.14).
- Rotate the filter retainer (10a) as shown in fig.15 and remove the Hepa filter (10) (fig.16).
- Rinse the filter in cold running water. Shake it gently after washing to eliminate any residual dirt and excess water.
- Replace the filter if it is torn.
- The filter should be cleaned every 4 months.

WARNING: do not clean filters with the brush, as this could damage them, decreasing their filtering capacity.

Do not use detergents, do not scrape filters, and do not wash them in a dishwasher.

CARE OF YOUR APPLIANCE

- Before attempting any maintenance operation, make sure to always disconnect the appliance from the mains
- To clean the body of the appliance, simply use a moist cloth.

LECOLOGICO AS 870 PARQUET

TROUBLESHOOTING

TROUBLE	CAUSE	SOLUTION
The vacuum cleaner does not start	Lack of voltage	Check cable, plug and socket
The vacuum cleaner switches off during suction and the four indicator lights flash	The liquid level in the container is too high The selected power is too high for the type of surface	In both cases, press the main switch (1), unplug the power cable and leave it unplugged for a few seconds in order to reset the safety device.
The suction power decreases	The nozzle, hose or accessories may be blocked up, or the Hepa filter may be dirty.	Clean the Hepa filter and remove any obstructions from the hose.
Water leaks during suction of liquids	The float is obstructed	Clean the filter assembly and make sure that the water level in the container is correct.

